

# METROPOLI

alberto meda, paolo rizzatto, riccardo sarfatti

D20

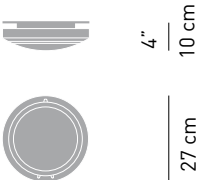



D20/27 p - D20/27 pw - D20/27 v  
weight 3.28 lb                      weight 4.32 lb

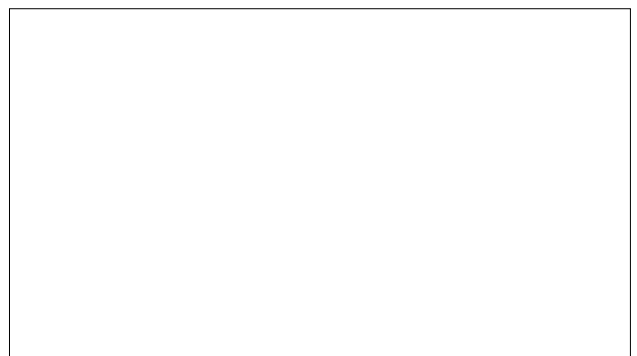

4" 10 cm  
27 cm



Lamp

 <b>D20/271</b> 100W A-19 med. base	 <b>D20/27.4 EL</b> 2x18W CFQ G24 q-2 (120-277V - electronic ballast)
 <b>D20/271</b> 75W T-10 halogen med. base	 <b>D20/27.5</b> 2x13W CFQ GX23-2
 <b>D20/271</b> 23W CFEL med. base	



Materials  
die-cast aluminium body moulded glass or polycarbonate diffuser

Structure finishes  
 white       painted alu       polished

Diffuser finishes  
 opaline polycarbonate       prismatic glass

Note  
incandescent and halogen versions are only with glass diffuser  
"P" version is suitable for damp locations. "P" version with fluo optics and "PW" version are suitable for wet locations

