

# KOINE'

design Mandalaki

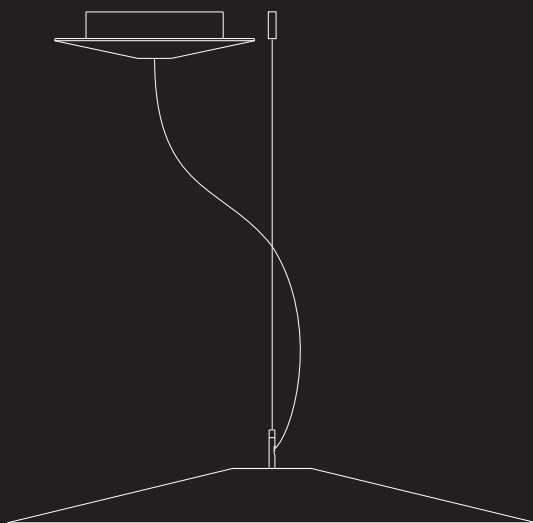

**LUCE  
PLAN**

A07



A07/1D

A07/1T

A07/2D

A07/2T

A07/3D

A07/3T

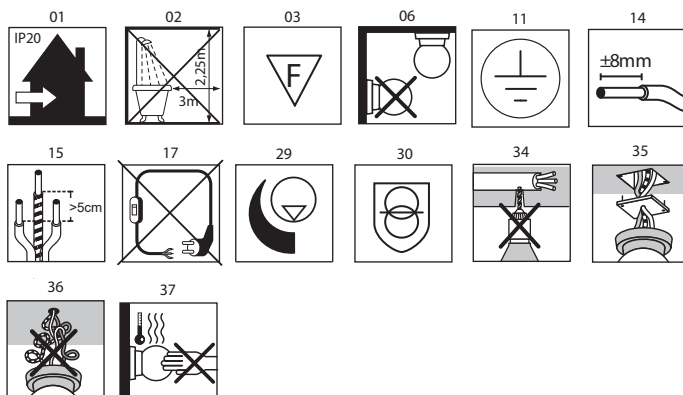

A07S20

A07S37

A07S55

A07S11

A07F86

A07F11

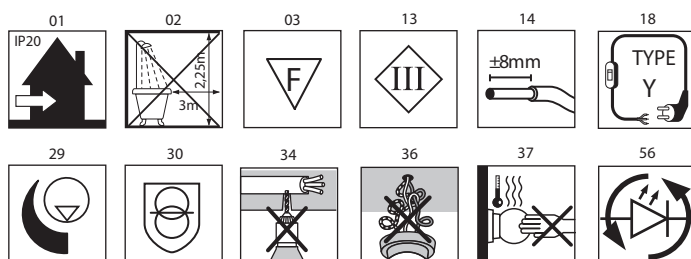

Iin: 350mA - 750mA (pag.3)

Vin: Max 35 Vdc SELV



Il prodotto NON deve essere collegato direttamente alla tensione di rete. Utilizzare la adeguata unita di alimentazione!

The product must NOT be connected directly to the mains voltage. Use the appropriate power supply unit.

Das Produkt darf nicht an die Netzspannung direkt angeschlossen werden.

Le produit NE DOIT PAS être connecté directement a la réseau électrique. Utilisez la correcte alimentation électrique.

El producto no debe ser conectado directamente a la red eléctrica. Utilice la fuente de alimentación correcta.

A07/1D  
A07/1T

A07/2D  
A07/2T

A07/3D  
A07/3T



1x



A07S20 max 350mA  
A07S37 max 550mA  
A07S55 max 550mA

1x

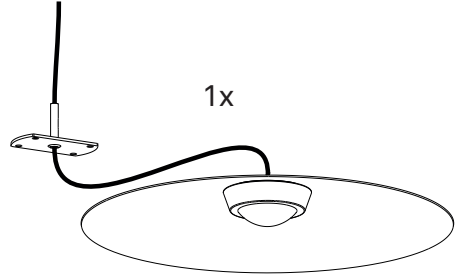

A07S11 max 750mA

1x



1x



4x



2x

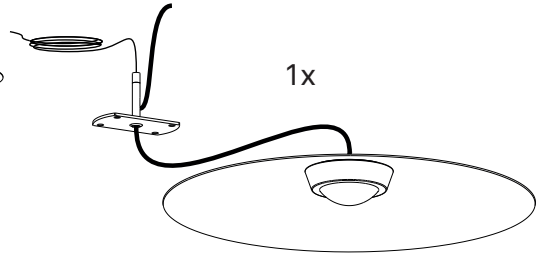

A07F86 max 550mA  
A07F11 max 750mA

1x



1x



4x



2x

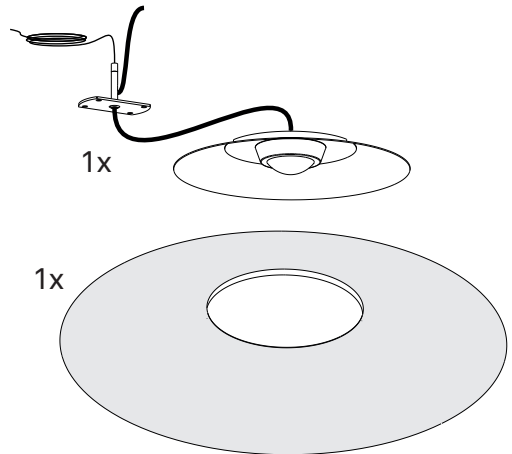

A07/1D

A07/1T

A07/2D

A07/2T

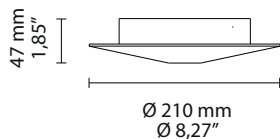

A07/3D

A07/3T

**kg** 0,5kg **lb** 1,1lbs

A07S20

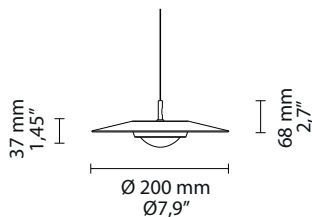

**kg** 0,4kg **lb** 0,9lbs

A07S37

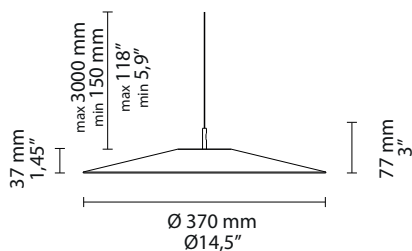

**kg** 0,8kg **lb** 1,8lbs

A07S55

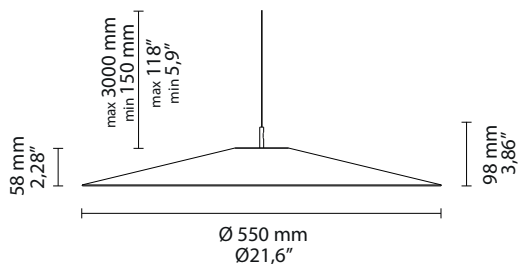

**kg** 1,3kg **lb** 2,9lbs



### A07S11

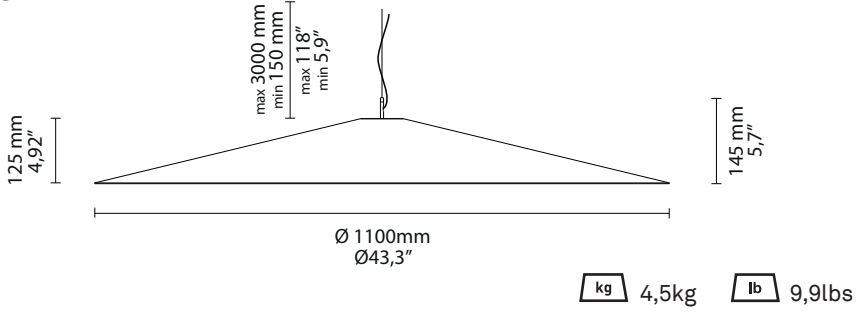

### A07F86

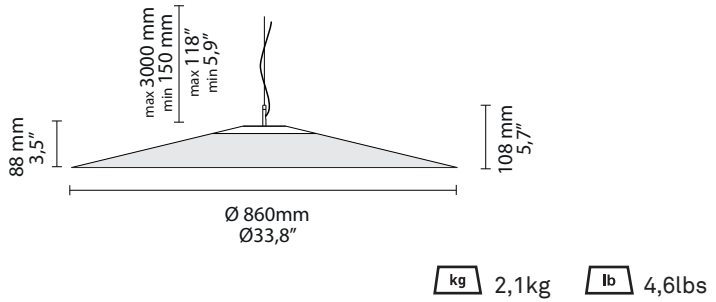

### A07F11

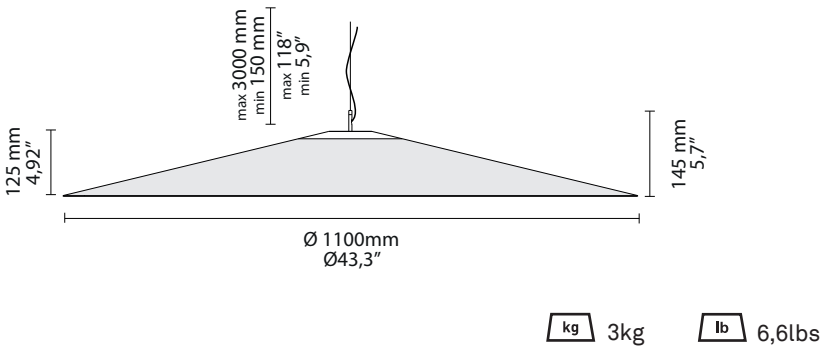

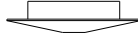

A07/1D  
A07/1T

A07/2D  
A07/2T

A07/3D  
A07/3T

A07S37



A07S11

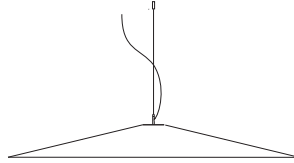

A07S20



A07S55



A07F86

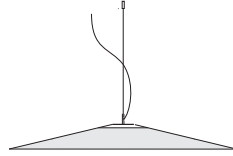

A07F11

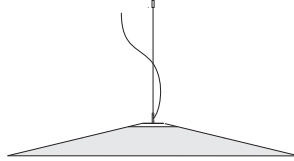

remote  
LED driver

Iout: max 550mAcd  
Vout: max 35 Vdc  
SELV

Iout: max 750mAcd  
Vout: max 35 Vdc  
SELV

Iout: max 350mAcd  
Vout: max 35 Vdc  
SELV

A07S37



A07S11

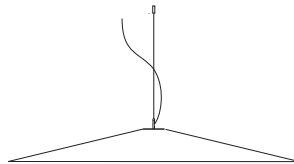

A07S20



A07S55

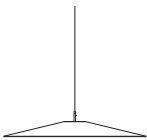

A07F86

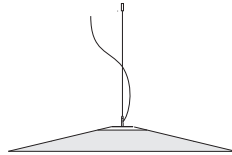

A07F11

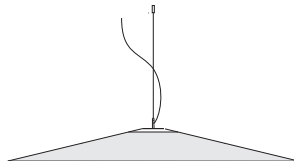



A07/1D  
A07/2D  
A07/3D

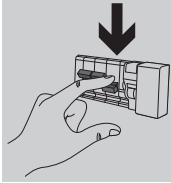

1

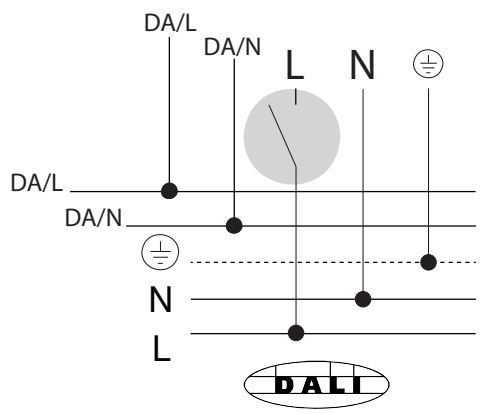
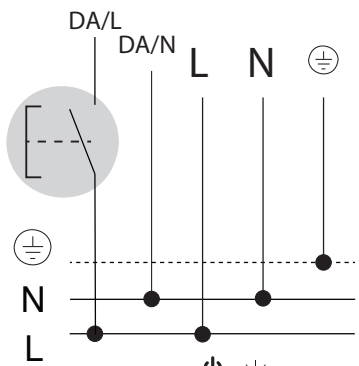
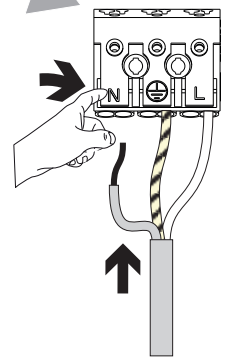
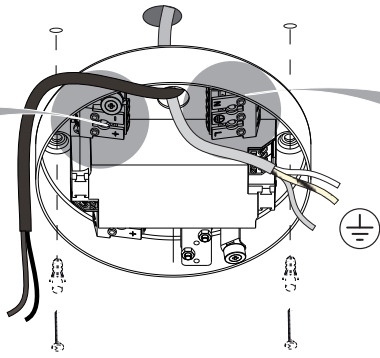
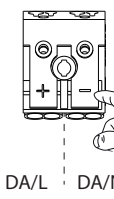
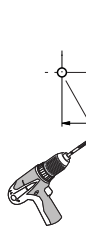
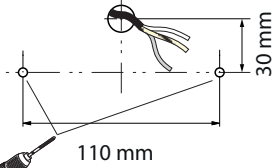
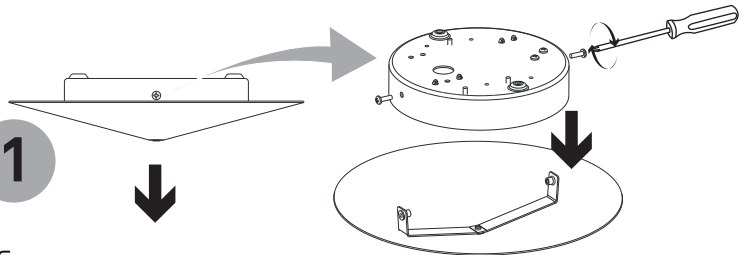

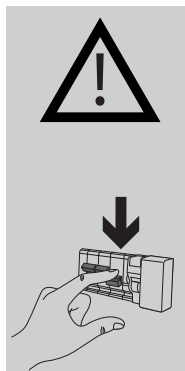

A07/1T  
A07/2T  
A07/3T

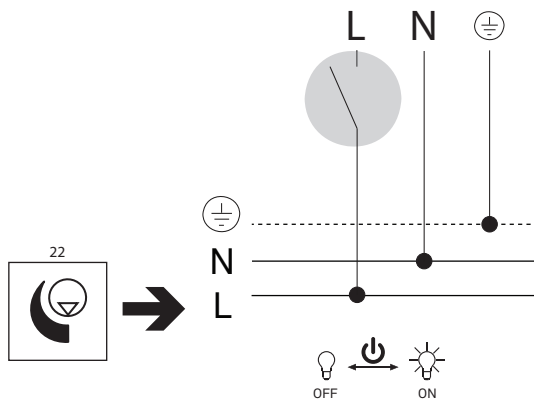
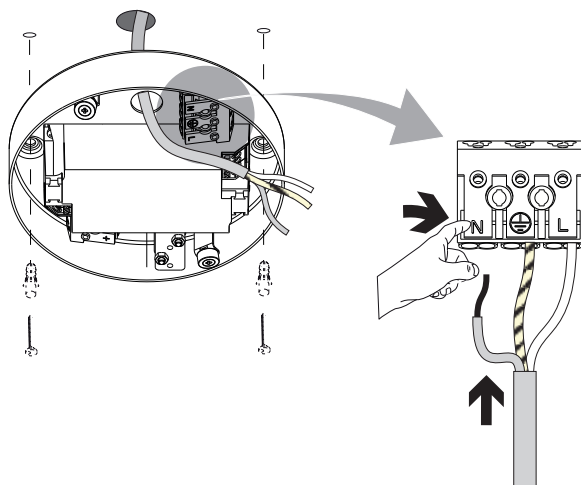
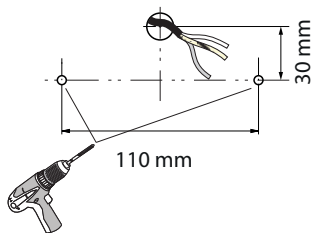
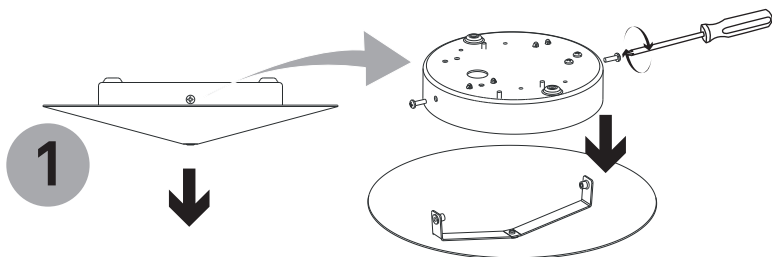

A07S20  
A07S37  
A07S55

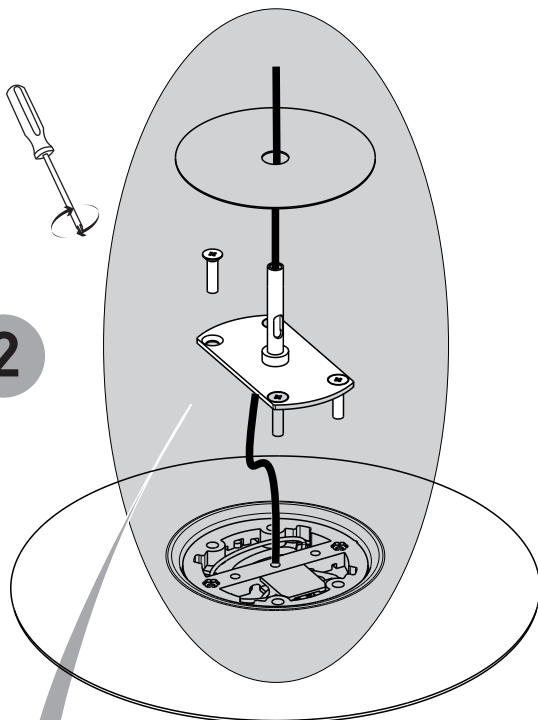

2

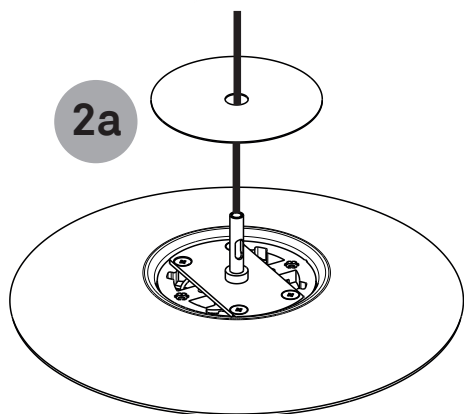
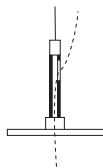
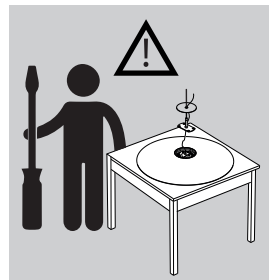

2a

2b

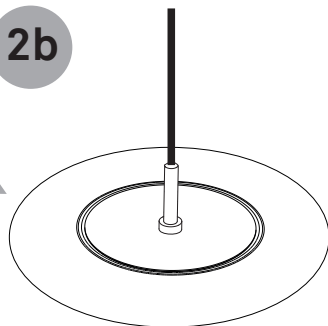

A07S11

A07F86

A07F11



2

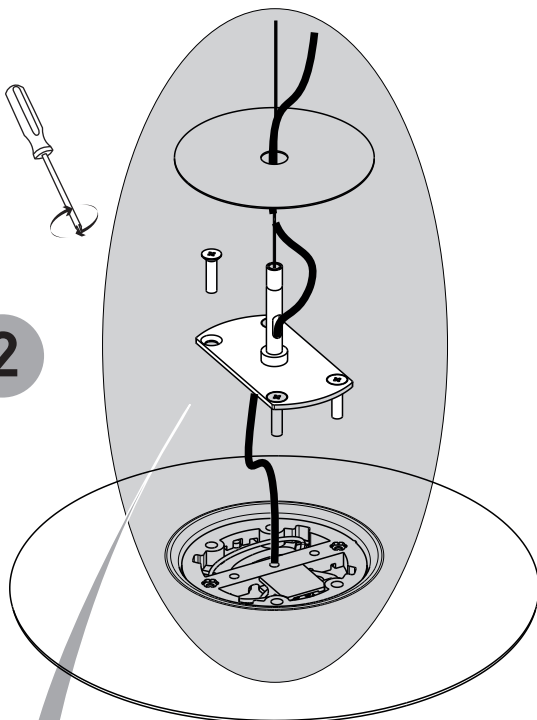
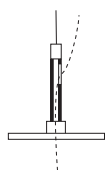

2a

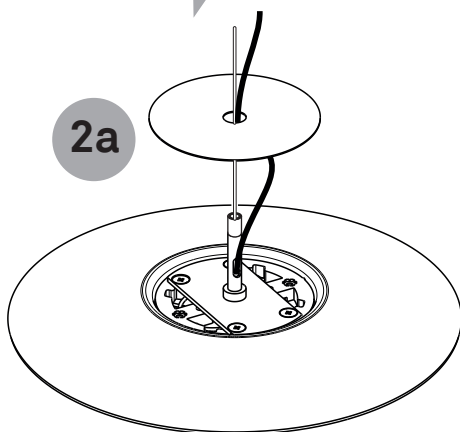

2b

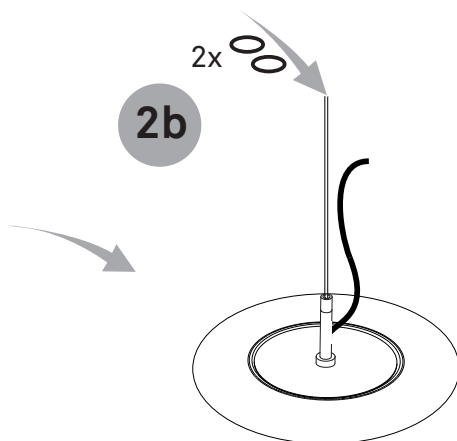

A07F86  
A07F11

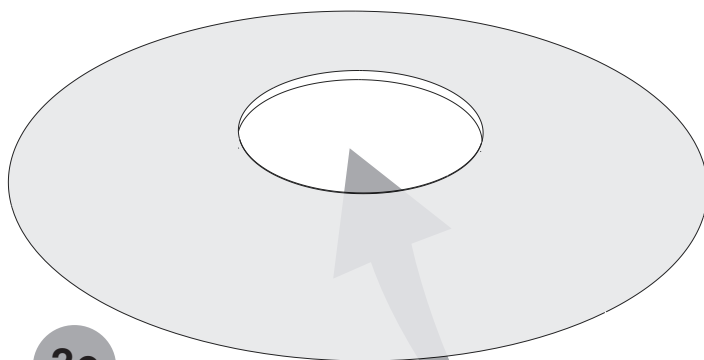

2c

Inserire il corpo led nell'elemento fonoassorbente prima di cablare al rosone.

Insert the LED body into the sound-absorbing element before wiring the ceiling rose.

Setzen Sie den LED-Körper in das schallabsorbierende Element ein, bevor Sie ihn mit dem Deckenbaldachin verkabeln

Insérez le LED dans l'élément insonorisant avant le câblage à la rosace de plafond

Introduzca el cuerpo del LED en el elemento fonoabsorbente antes de cablearlo en el rosetón.

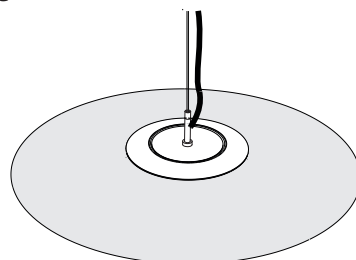
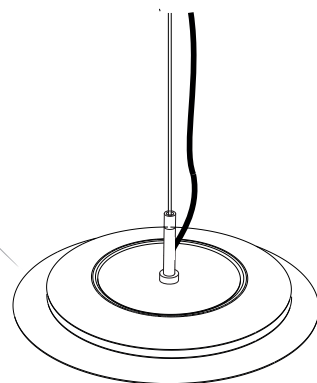

A07S11

A07F86

A07F11

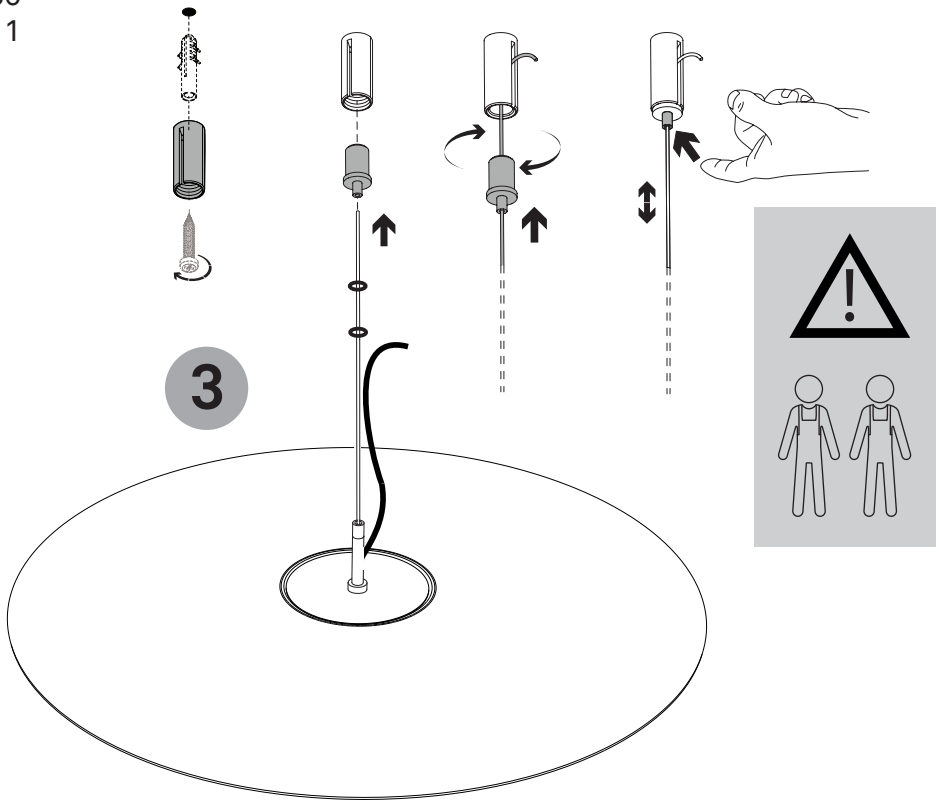

Regolare l'altezza di installazione (L) prima di effettuare il collegamento elettrico.

Adjust the installation height (L) before making the electrical connection

Passen Sie die Installationshöhe (L) an bevor Sie den elektrischen Anschluss vornehmen

Règlez l'hauteur d'installation (L) avant d'effectuer le raccordement électrique

Ajuste la altura de instalación (L) antes de realizar la conexión eléctrica

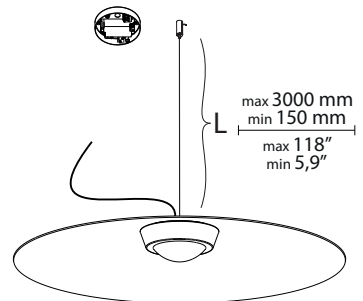



A07S11

A07F86

A07F11

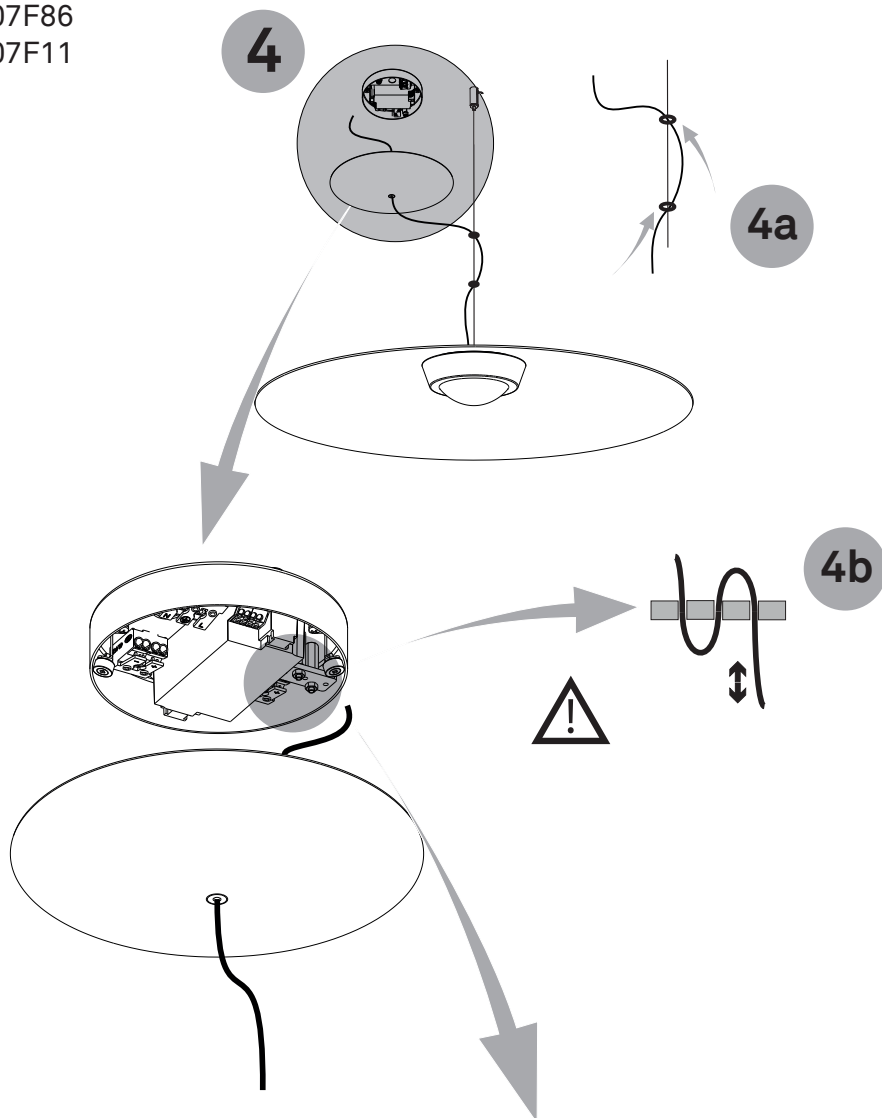

A07S20  
A07S37  
A07S55

A07S11

A07F86  
A07F11

4c

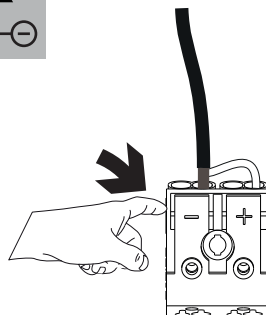
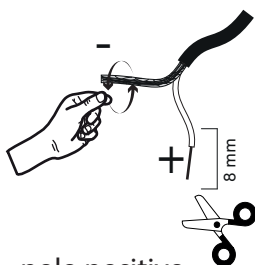
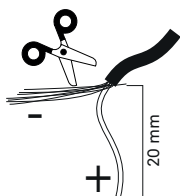
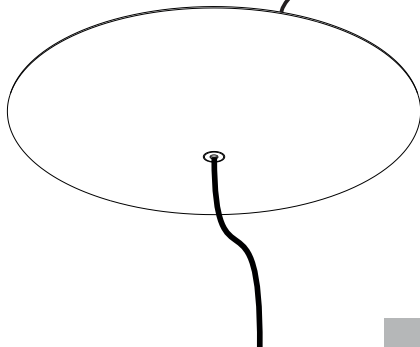
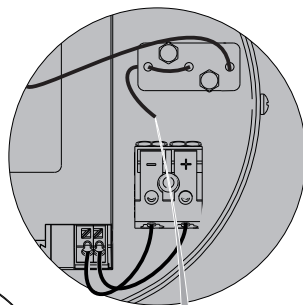
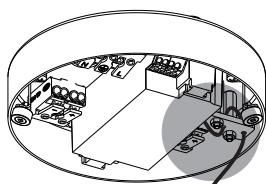

polo positivo  
positive pole  
Pluspol pole  
pôle positif  
terminal positivo

conduttore con guaina interno  
inner sheathed conductor  
Leiter mit innerer Umhüllung  
conducteur avec gaine intérieure  
conductor con vaina interior

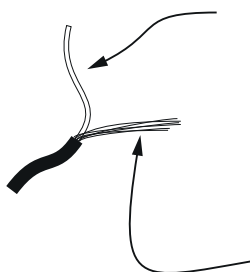

polo negativo  
negative pole  
Minus pole  
pôle négatif  
terminal negativo

rivestimento esterno  
outer jacket  
Außenbeschichtung  
revêtement extérieur  
revestimiento exterior

A07S20  
A07S37  
A07S55

A07S11

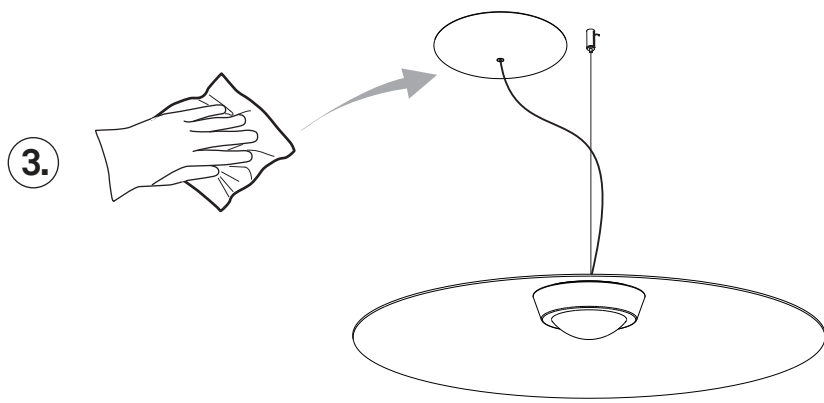
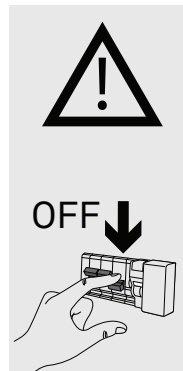
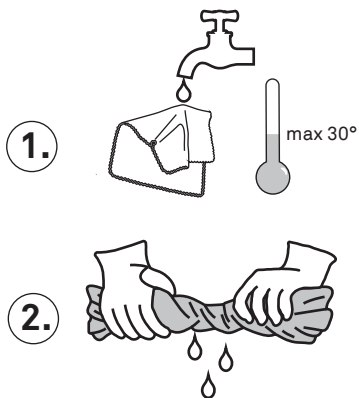

A07F86  
A07F11

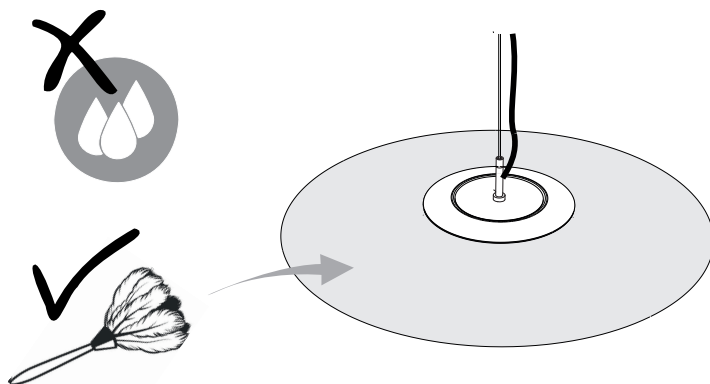

## ECODESIGN

### SYMBOL LEGEND

### LEGENDA DEI SIMBOLI

### ERLAEUTERUNG DER SYMBOLE

### LEGENDE DES SYMBOLES

### LEYENDA DE LOS SIMBOLOS



Replaceable light source by end-user  
Fonte luminosa sostituibile dal cliente finale  
Auswechselbare Lichtquelle durch den Endanwender  
Source lumineuse remplaçable par l'utilisateur final  
Fuente de luz reemplazable por el usuario final



Replaceable light source by a professional  
Fonte luminosa sostituibile da un professionista  
Auswechselbare Lichtquelle durch einen Fachmann  
Source lumineuse remplaçable par un professionnel  
Fuente de luz reemplazable por un profesional



Replaceable (LED only) light source by end-user  
Fonte luminosa (solo LED) sostituibile dal cliente finale  
Auswechselbare (nur LED) Lichtquelle durch den Endanwender  
Source lumineuse remplaçable (LED uniquement) par l'utilisateur final  
Fuente de luz reemplazable (sólo LED) por el usuario final



Replaceable (LED only) light source by a professional  
Fonte luminosa (solo LED) sostituibile da un professionista  
Auswechselbare (nur LED) Lichtquelle durch einen Fachmann  
Source lumineuse remplaçable (LED uniquement) par un professionnel  
Fuente de luz reemplazable (sólo LED) por un profesional



Non-replaceable light source  
Fonte luminosa non sostituibile  
Nicht austauschbare Lichtquelle  
Source lumineuse non remplaçable  
Fuente de luz no reemplazable



Replaceable control gear by an end-user  
Unità di alimentazione sostituibile dal cliente finale  
Austauschbares Vorschaltgerät durch einen Endanwender  
Pièce d'alimentation remplaçable par l'utilisateur final  
Unidad de alimentación reemplazable por el usuario final



Replaceable control gear by a professional  
Unità di alimentazione sostituibile da un professionista  
Austauschbares Vorschaltgerät durch einen Fachmann  
Pièce d'alimentation remplaçable par un professionnel  
Unidad de alimentación reemplazable por un profesional

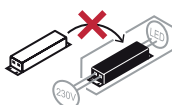

Non-replaceable control gear  
Unità di alimentazione non sostituibile  
Nicht austauschbares Vorschaltgerät  
Pièce d'alimentation non remplaçable  
Unidad de alimentación no reemplazable











[www.luceplan.com](http://www.luceplan.com)

A070IB001