

# LUTHIEN

design Monica Armani

---

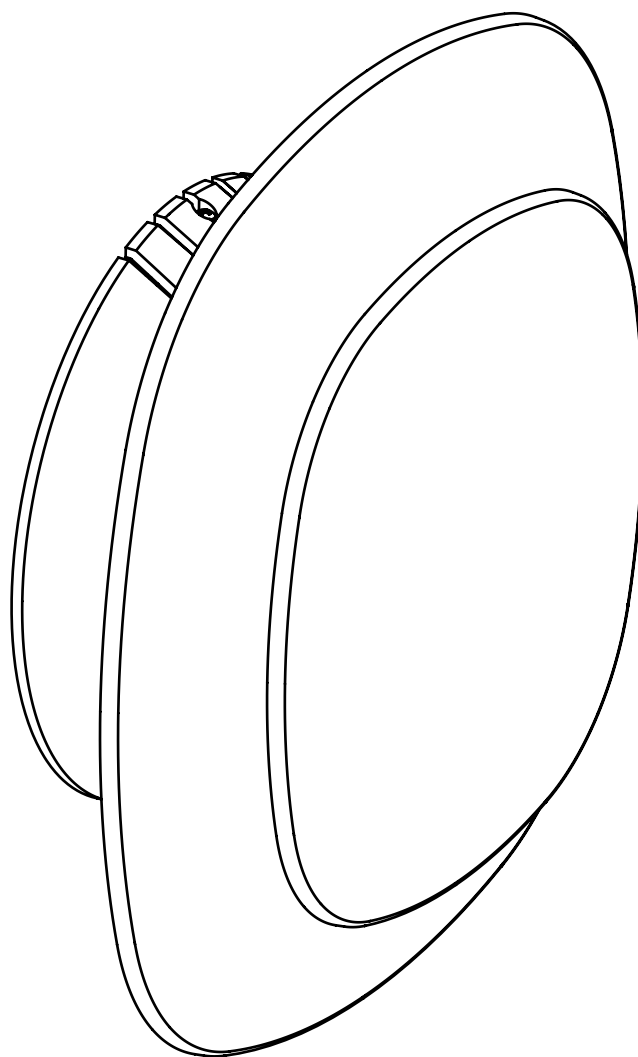

**LUCE  
PLAN**

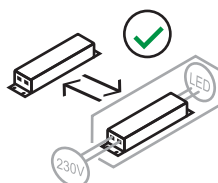
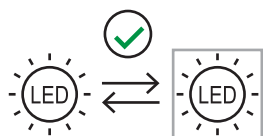

---

D85

---

# ECODESIGN

EN SYMBOL LEGEND  
 IT LEGENDA DEI SIMBOLI  
 DE ERLAEUTERUNG DER SYMBOLE  
 FR LEGENDE DES SYMBOLES  
 ES LEYENDA DE LOS SIMBOLOS

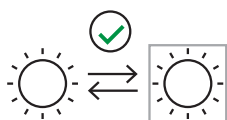

EN Replaceable light source by end-user  
 IT Fonte luminosa sostituibile dal cliente finale  
 DE Auswechselbare Lichtquelle durch den Endanwender  
 FR Source lumineuse remplaçable par l'utilisateur final  
 ES Fuente de luz reemplazable por el usuario final

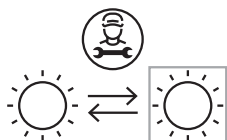

EN Replaceable light source by a professional  
 IT Fonte luminosa sostituibile da un professionista  
 DE Auswechselbare Lichtquelle durch einen Fachmann  
 FR Source lumineuse remplaçable par un professionnel  
 ES Fuente de luz reemplazable por un profesional

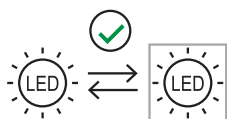

EN Replaceable (LED only) light source by end-user  
 IT Fonte luminosa (solo LED) sostituibile dal cliente finale  
 DE Auswechselbare (nur LED) Lichtquelle durch den Endanwender  
 FR Source lumineuse remplaçable (LED uniquement) par l'utilisateur final  
 ES Fuente de luz reemplazable (sólo LED) por el usuario final

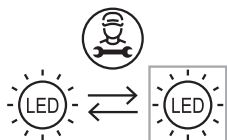

EN Replaceable (LED only) light source by a professional  
 IT Fonte luminosa (solo LED) sostituibile da un professionista  
 DE Auswechselbare (nur LED) Lichtquelle durch einen Fachmann  
 FR Source lumineuse remplaçable (LED uniquement) par un professionnel  
 ES Fuente de luz reemplazable (sólo LED) por un profesional



EN Non-replaceable light source  
 IT Fonte luminosa non sostituibile  
 DE Nicht austauschbare Lichtquelle  
 FR Source lumineuse non remplaçable  
 ES Fuente de luz no reemplazable

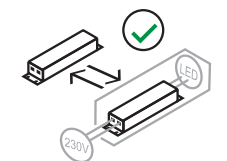

EN Replaceable control gear by a end-user  
 IT Unità di alimentazione sostituibile dal cliente finale  
 DE Austauschbares Vorschaltgerät durch einen Endanwender  
 FR Pièce d'alimentation remplaçable par l'utilisateur final  
 ES Unidad de alimentación reemplazable por el usuario final

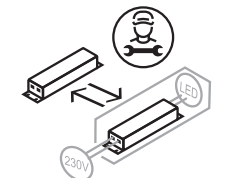

EN Replaceable control gear by a professional  
 IT Unità di alimentazione sostituibile da un professionista  
 DE Austauschbares Vorschaltgerät durch einen Fachmann  
 FR Pièce d'alimentation remplaçable par un professionnel  
 ES Unidad de alimentación reemplazable por un profesional

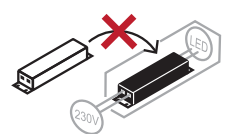

EN Non-replaceable control gear  
 IT Unità di alimentazione non sostituibile  
 DE Nicht austauschbares Vorschaltgerät  
 FR Pièce d'alimentation non remplaçable  
 ES Unidad de alimentación no reemplazable

EN USE ONLY ORIGINAL SPARE PARTS  
 IT UTILIZZARE SOLO RICAMBI ORIGINALI  
 DE VERWENDEN SIE NUR ORIGINAL-ERSATZTEILE  
 FR UTILISER SEULEMENT DES PIÈCES DE RECHANGE D'ORIGINE  
 ES UTILIZAR EXCLUSIVAMENTE REPUESTOS ORIGINALES

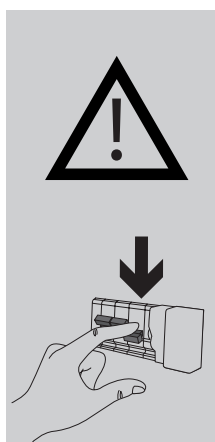
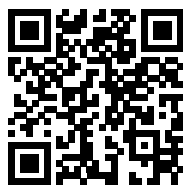
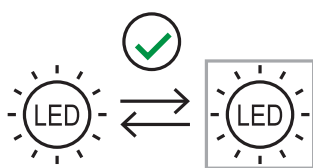

1

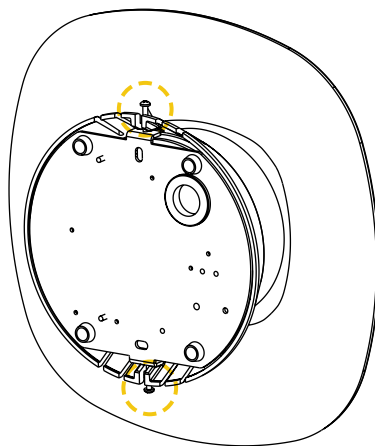
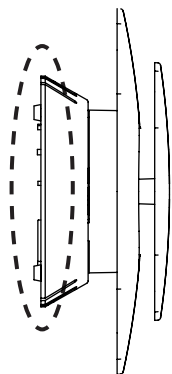

2

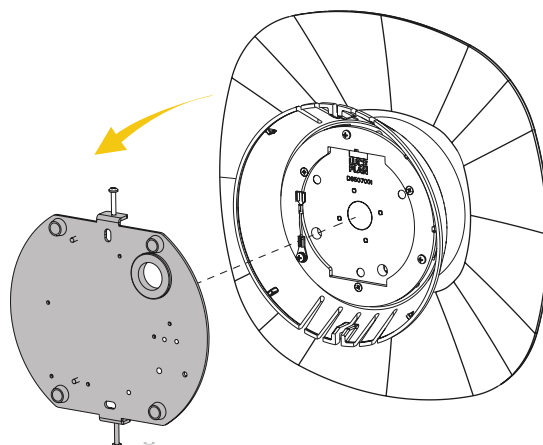

3

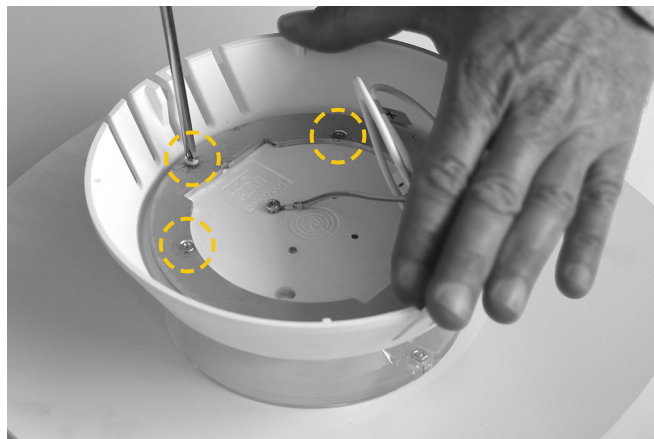

4

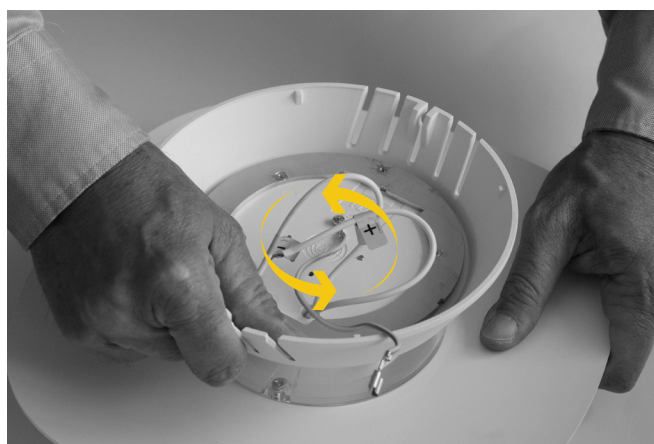

5

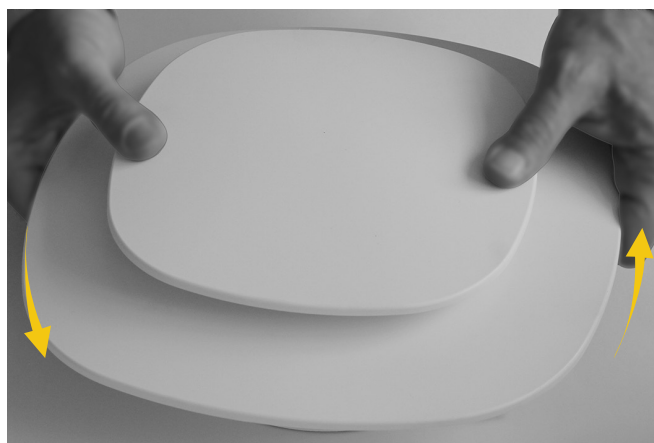

6

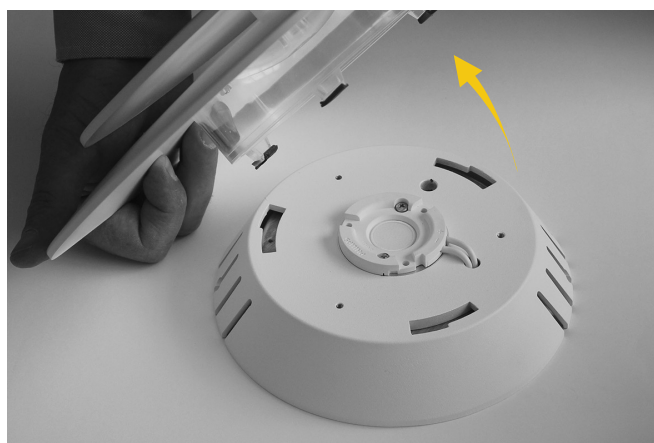

7



8

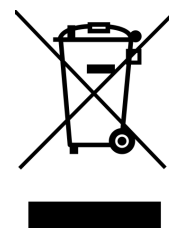
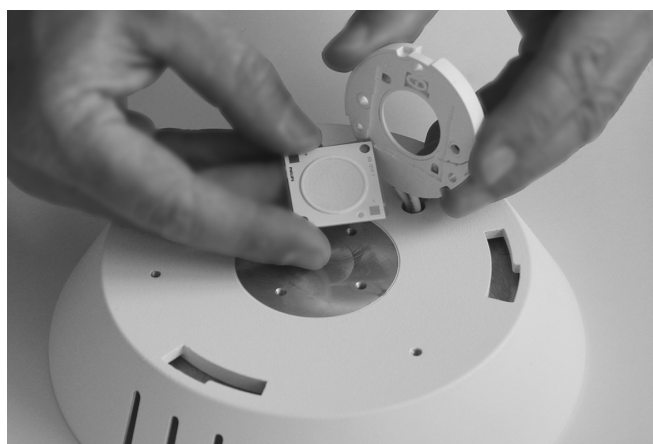

- EN** Replace the old component with the new one by reversing the sequence.
- IT** Sostituire il vecchio componente con il nuovo, invertendo la sequenza.
- DE** Ersetzen die alte Komponente mit einer Neue beim Umkehren der Reihenfolge.
- FR** Remplacer l'ancienne pièce par la nouvelle, en inversant la séquence.
- ES** Sustituir el componente antiguo por el nuevo, invirtiendo la secuencia.

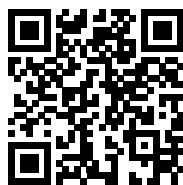
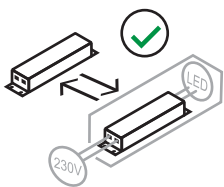

- EN ALIM.LED tg.fase  
 IT ALIM.LED phase cut  
 DE ALIM.LED Phasenabschnitt Alimentateur  
 FR LED coupure de phase  
 ES Alimentador LED corte de fase

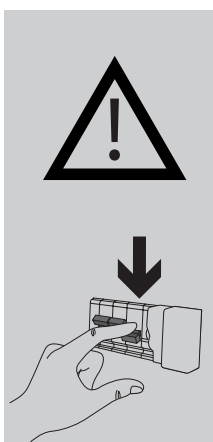

1

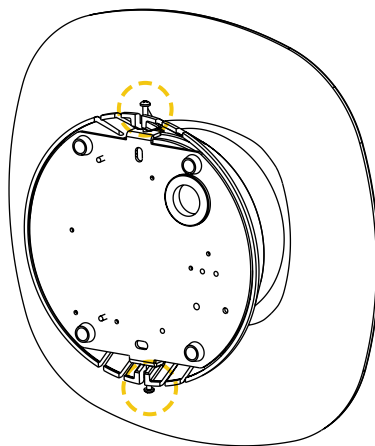
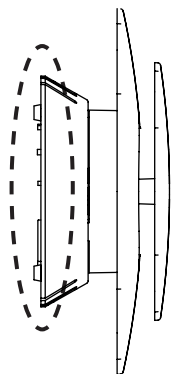

2

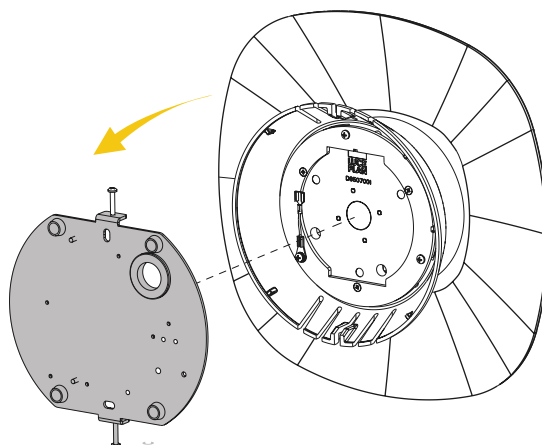

3

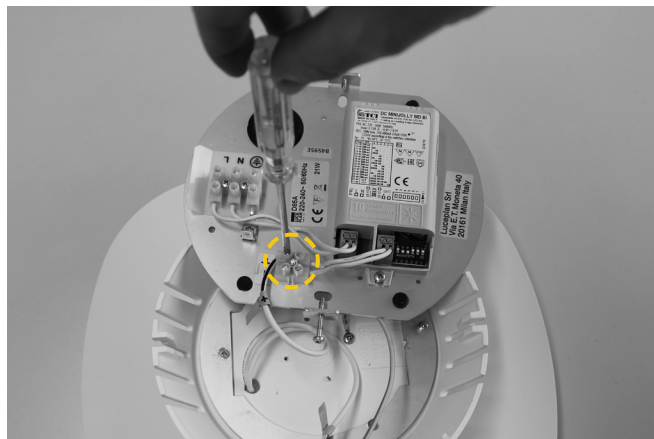

4

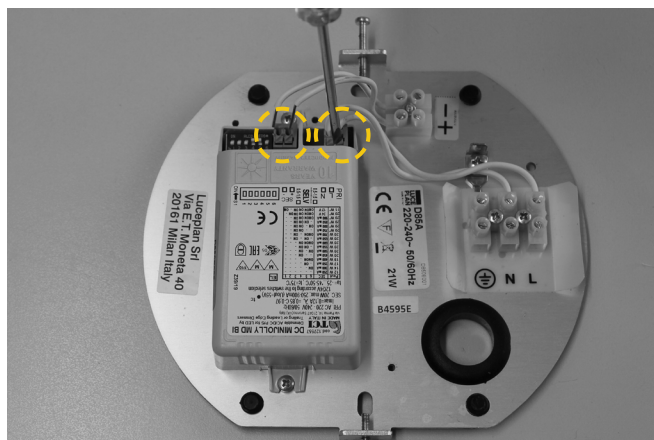

550mA

5

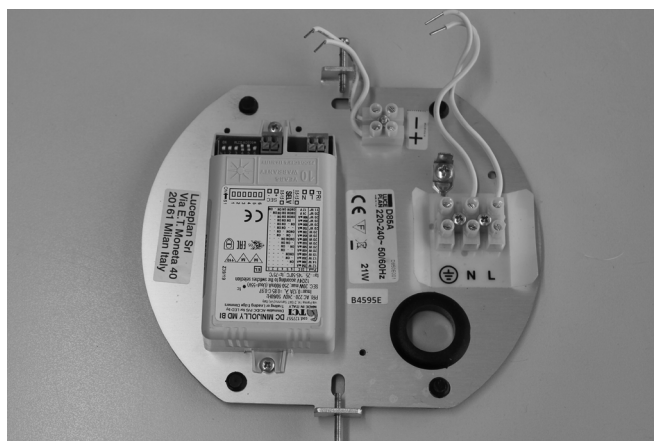

6

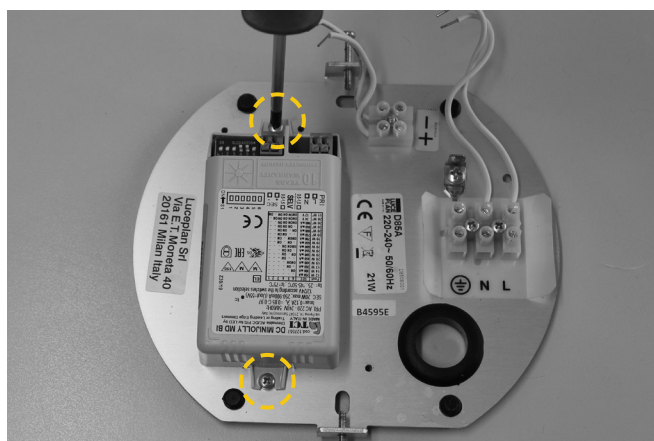



7

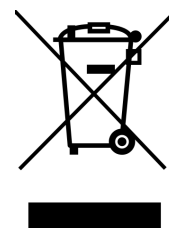
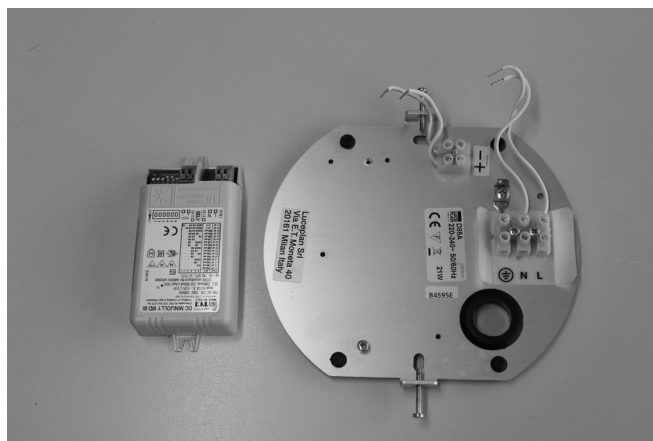

- EN** Replace the old component with the new one by reversing the sequence.
- IT** Sostituire il vecchio componente con il nuovo, invertendo la sequenza.
- DE** Ersetzen die alte Komponente mit einer Neue beim Umkehren der Reihenfolge.
- FR** Remplacer l'ancienne pièce par la nouvelle, en inversant la séquence.
- ES** Sustituir el componente antiguo por el nuevo, invirtiendo la secuencia.



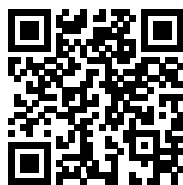
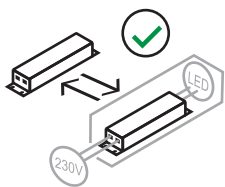

- EN ALIM.LED DALI
- IT ALIM.LED DALI
- DE ALIM.LED DALI
- FR Alimentateur LED DALI
- ES Alimentador LED DALI

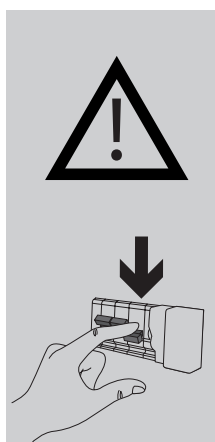

1

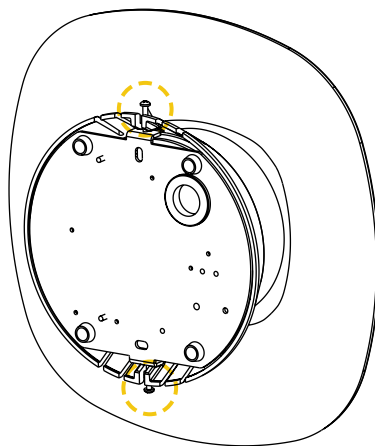
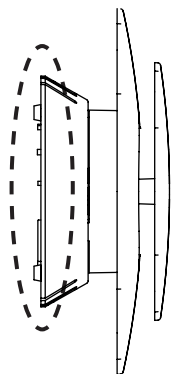

2

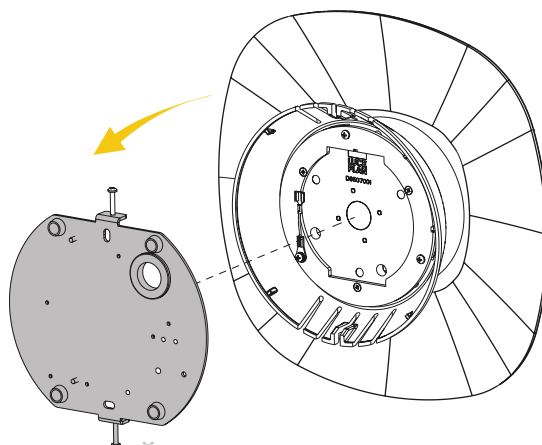

3

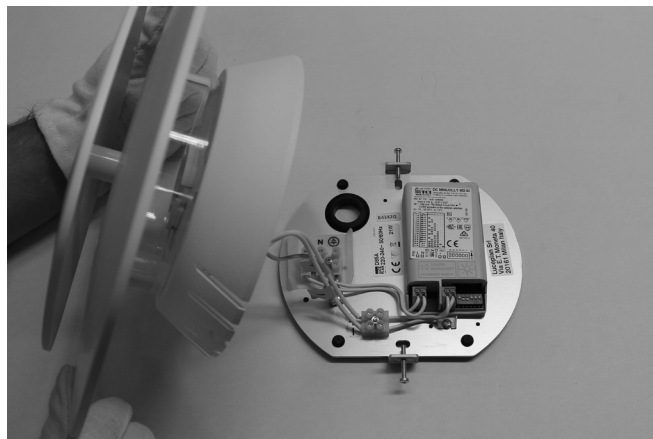

4

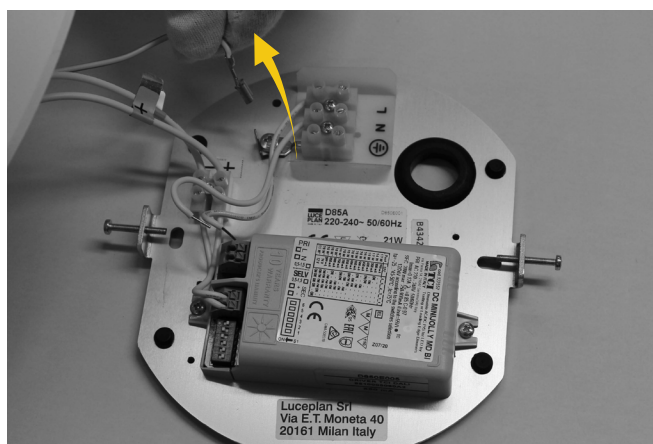

550mA

5

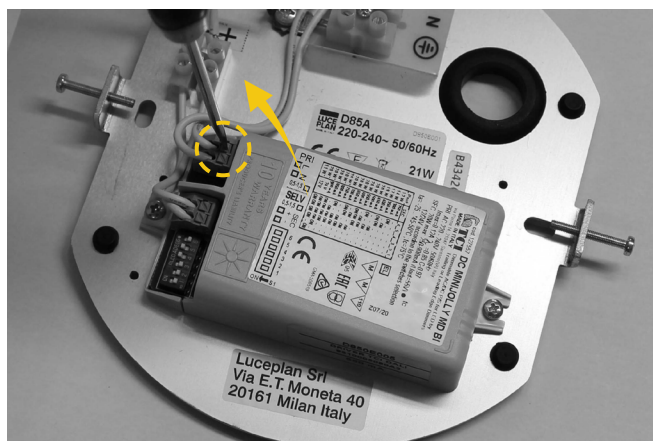

6



7

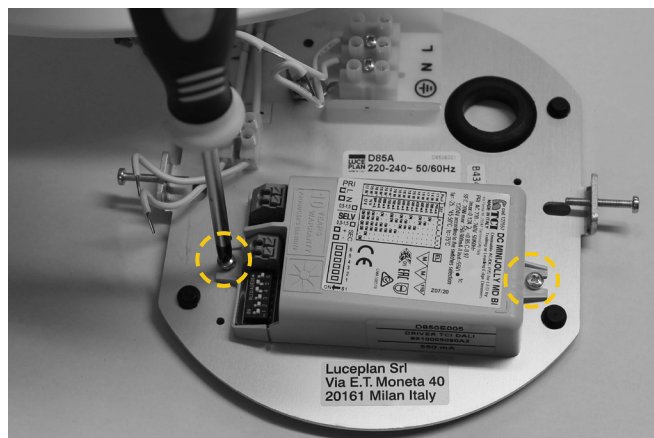

8

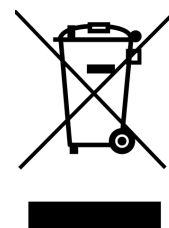
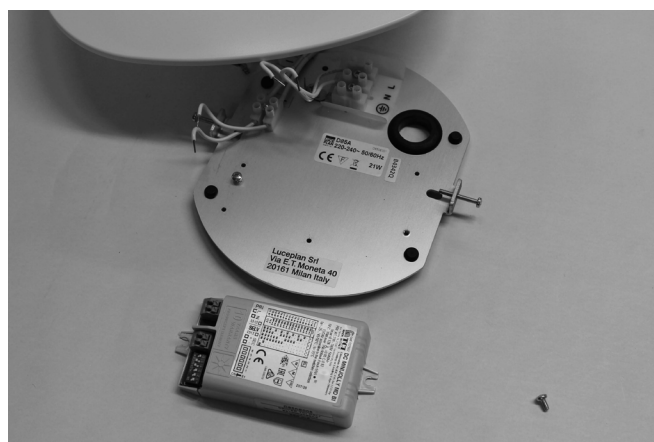

- EN** Replace the old component with the new one by reversing the sequence.
- IT** Sostituire il vecchio componente con il nuovo, invertendo la sequenza.
- DE** Ersetzen die alte Komponente mit einer Neue beim Umkehren der Reihenfolge.
- FR** Remplacer l'ancienne pièce par la nouvelle, en inversant la séquence.
- ES** Sustituir el componente antiguo por el nuevo, invirtiendo la secuencia.

